

ELECTRICAL GAUGES

SMOKE LENS SERIES AMBER RED & SUPER WHITE LED DISPLAY

(270° SCALE)

Fuel Press Gauge

OPENING CEREMONY

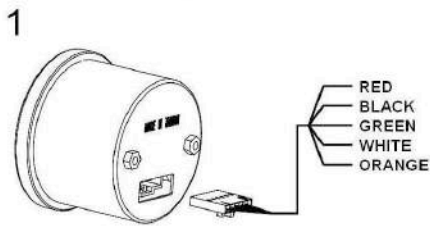

- RED - TO IGNITION SWITCH 12V(+)
- BLACK - BATTERY(-)
- GREEN - FUEL PRESS SENSOR
- WHITE - NOTE
- ORANGE - NOTE

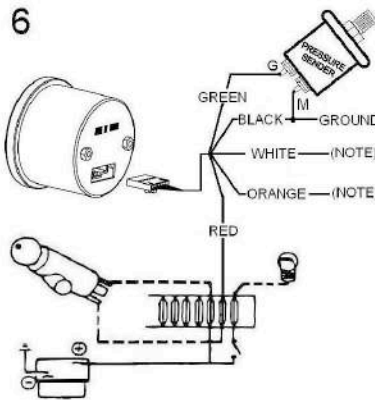
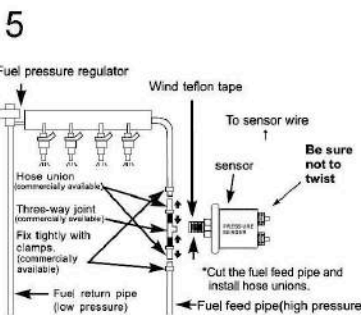
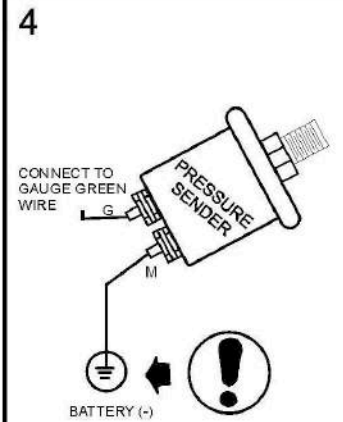
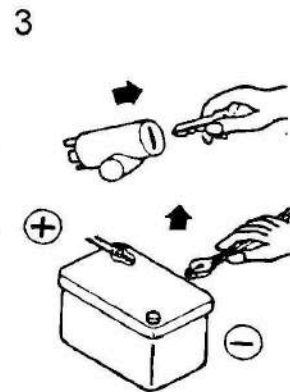
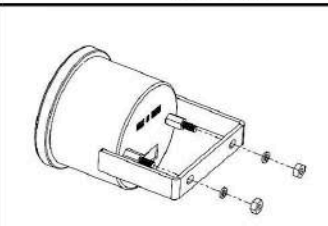
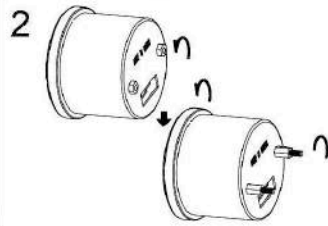

NOTE: GAUGE REQUIRE FUNCTION

REQUIRE FUNCTION		INSTALLATION
DAY TIME	NIGHT TIME	
WHITE SCALE	WHITE SCALE	WHITE WIRE→connect to ACC. AMBER WIRE→NO connect
AMBER SCALE	AMBER SCALE	WHITE WIRE→NO connect AMBER WIRE→connect to ACC.
WHITE SCALE	AMBER SCALE	WHITE WIRE→ connect to ACC AMBER WIRE→connect to PARKING LAMP
AMBER SCALE	WHITE SCALE	WHITE WIRE→connect to PARKING LAMP AMBER WIRE→connect to ACC.

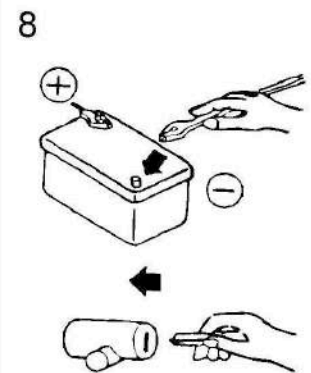

Boost / Vacuum Gauge

OPENING CEREMONY

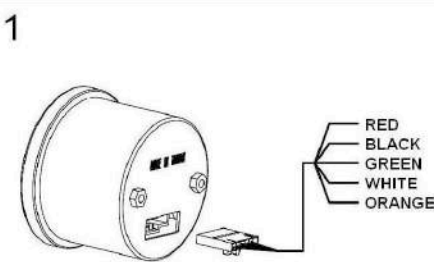

- RED - TO IGNITION SWITCH 12V(+)
- BLACK - BATTERY(-)
- GREEN - BOOST SENSOR
- WHITE - NOTE
- ORANGE - NOTE

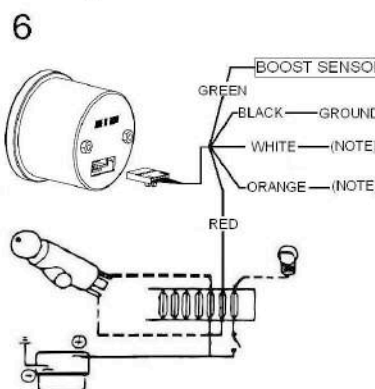
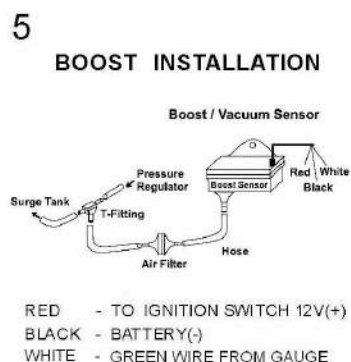
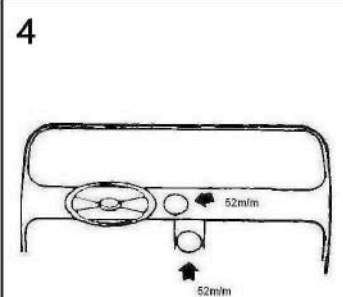
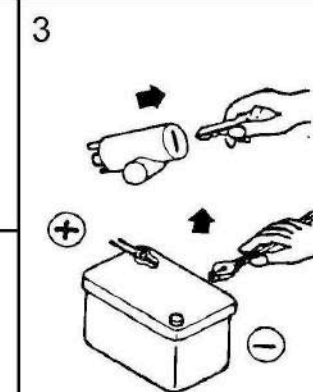
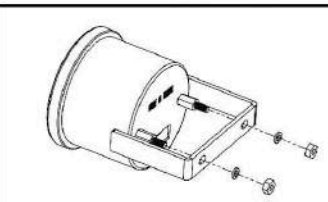
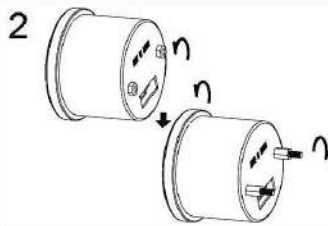

NOTE: GAUGE REQUIRE FUNCTION

REQUIRE FUNCTION		INSTALLATION
DAY TIME	NIGHT TIME	
WHITE SCALE	WHITE SCALE	WHITE WIRE→connect to ACC. AMBER WIRE→NO connect
AMBER SCALE	AMBER SCALE	WHITE WIRE→NO connect AMBER WIRE→connect to ACC.
WHITE SCALE	AMBER SCALE	WHITE WIRE→ connect to ACC AMBER WIRE→connect to PARKING LAMP
AMBER SCALE	WHITE SCALE	WHITE WIRE→connect to PARKING LAMP AMBER WIRE→connect to ACC.

